

1

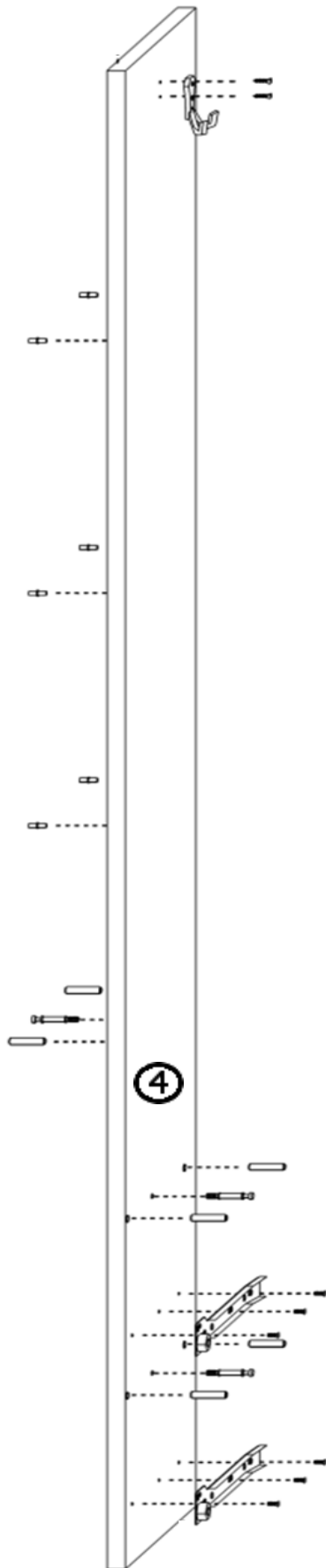

3



2

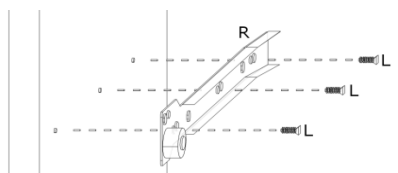
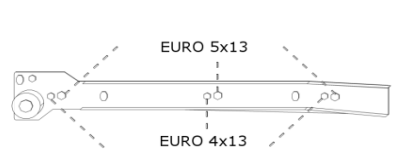
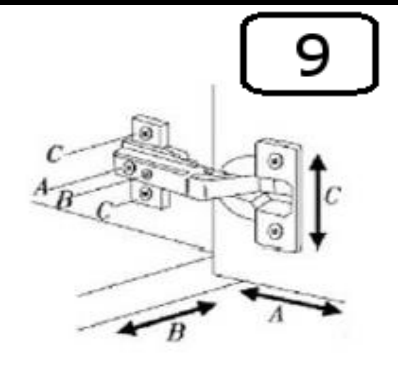
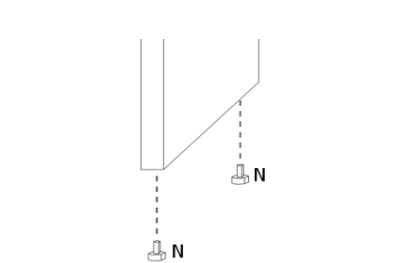
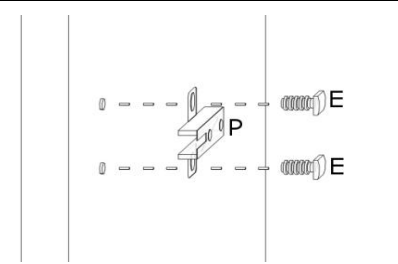
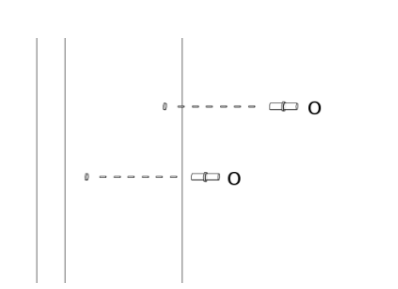
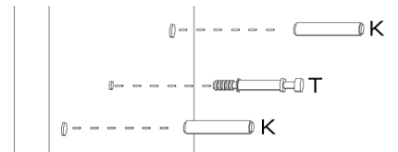
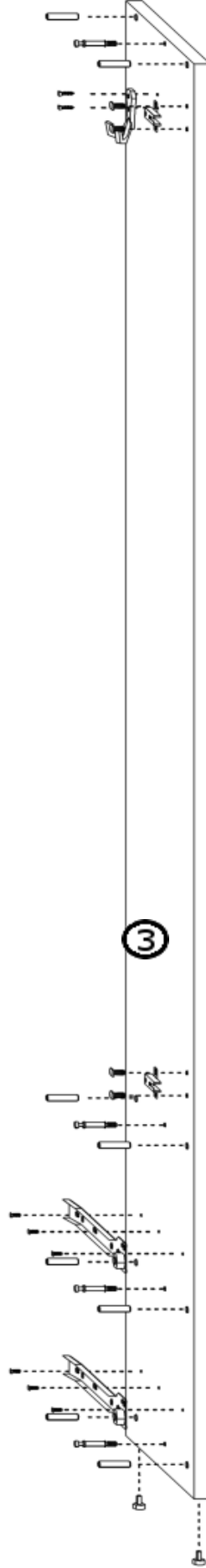

4 X

4

# INSTRUKCJA MONTAŻU

MONIA 2DP2SK

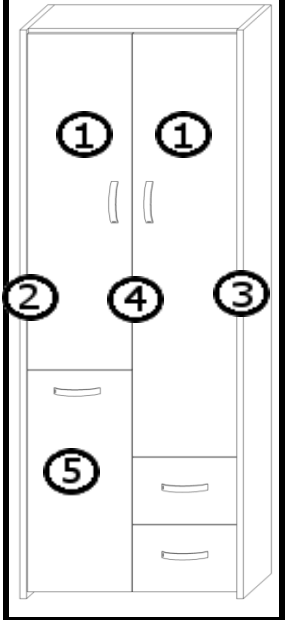
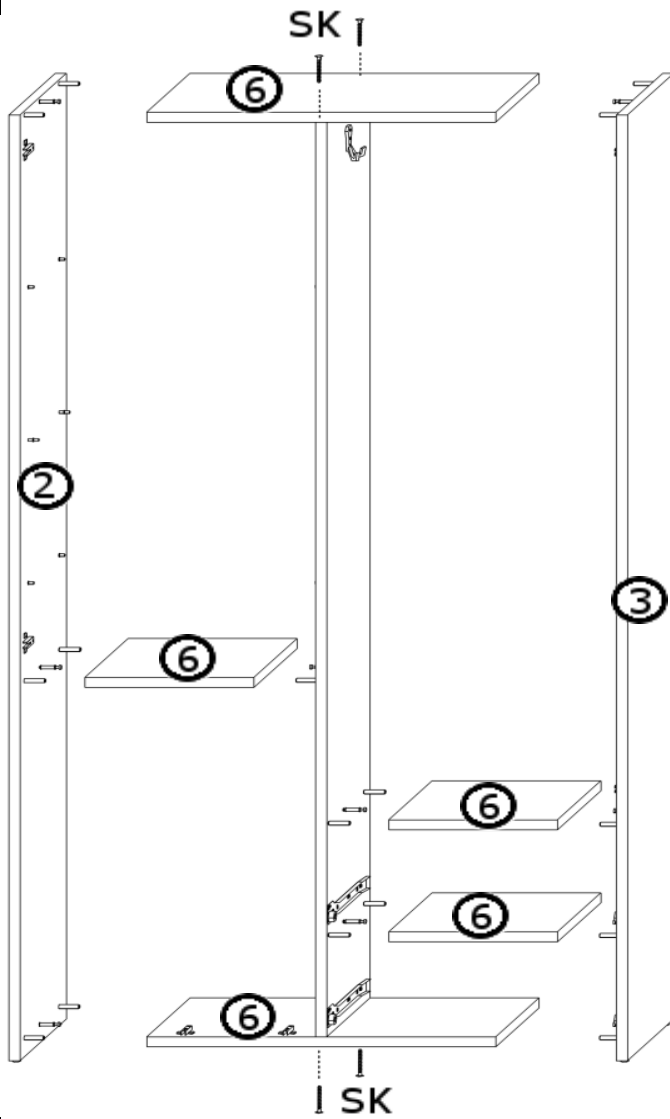
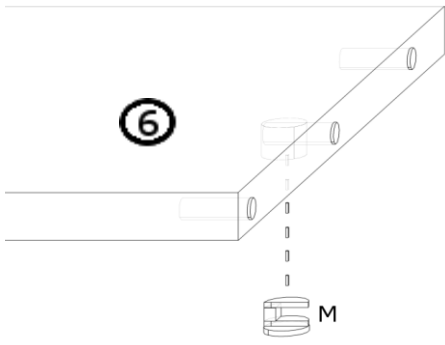

1 X

5

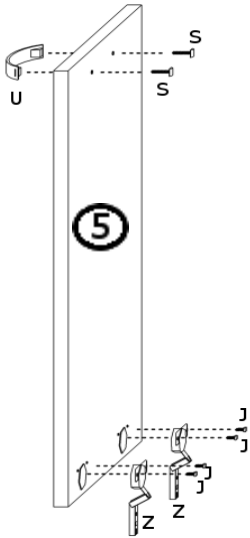

2 X

5

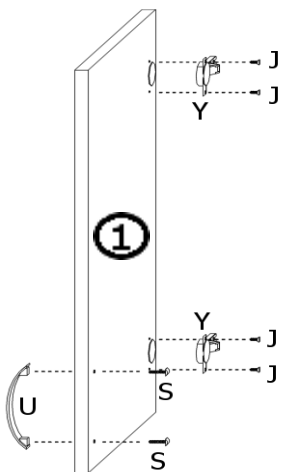



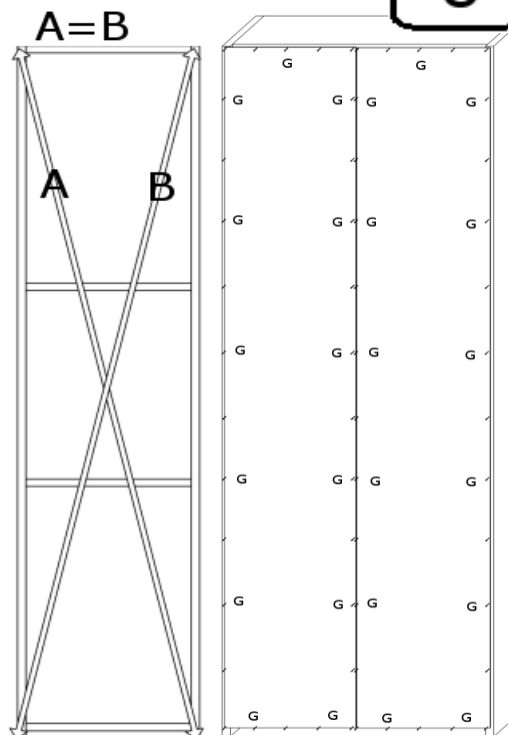



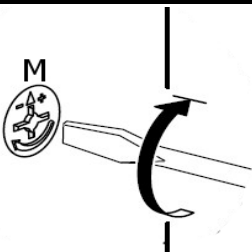







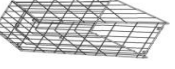

8

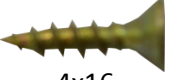

7

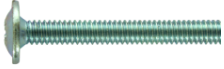

AKCESORIA

<p>G 50X</p> 	<p>R 2 KPL</p>  <p>250mm</p>	<p>KK 1X</p>  <p>KLUCZYK IMBUS</p>	<p>O 12X</p> 
<p>Z 2X</p>  <p>PRUSIY</p>	<p>Y 4X</p>  <p>WPUSZCZANY</p>	<p>1X</p> 	<p>M 18X</p> 
<p>K 28X</p> 	<p>U 5X</p>  <p>96mm</p>	<p>J 28X</p>  <p>4x16</p>	<p>T 18X</p> 
<p>SK 4X</p> 	<p>L 12X</p>  <p>4x13</p>	<p>N 4X</p> 	<p>S 10X</p> 
<p>2X</p> 	<p>OK. 1X</p> 		

1

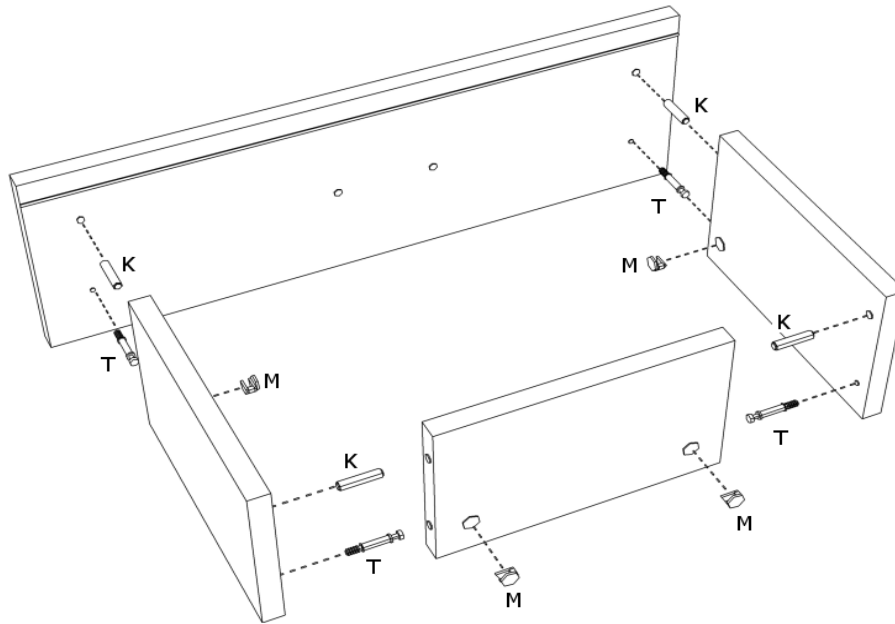

2

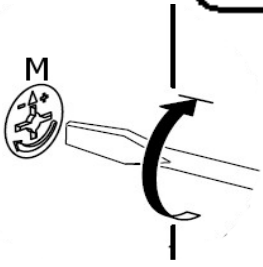

3

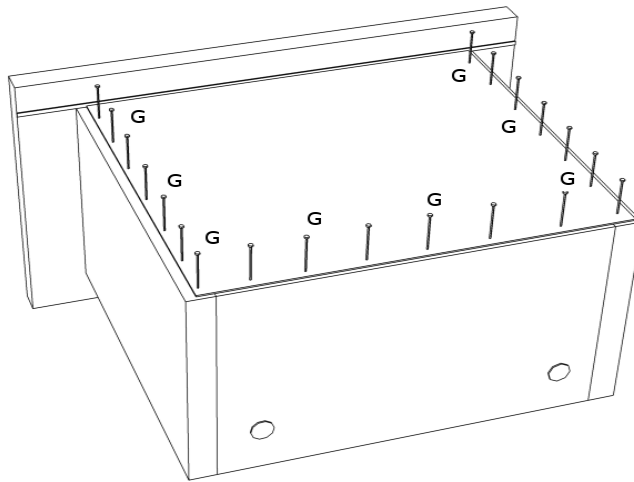

4

