

1

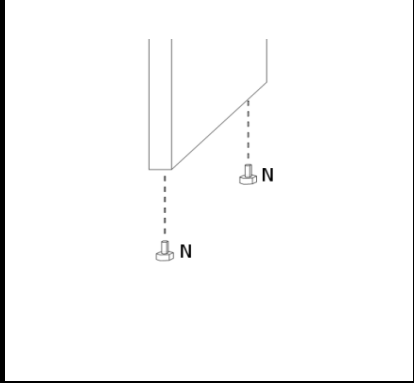

2

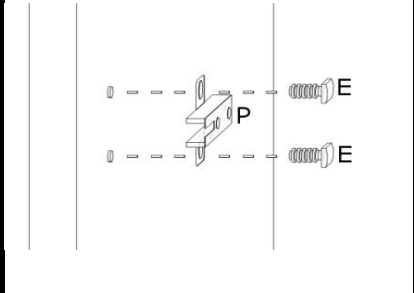
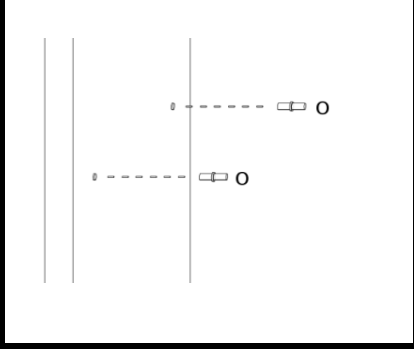
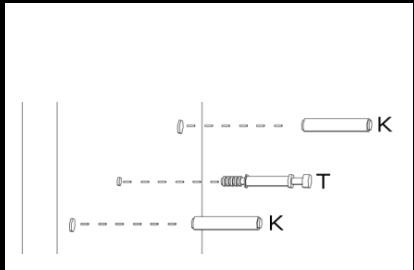
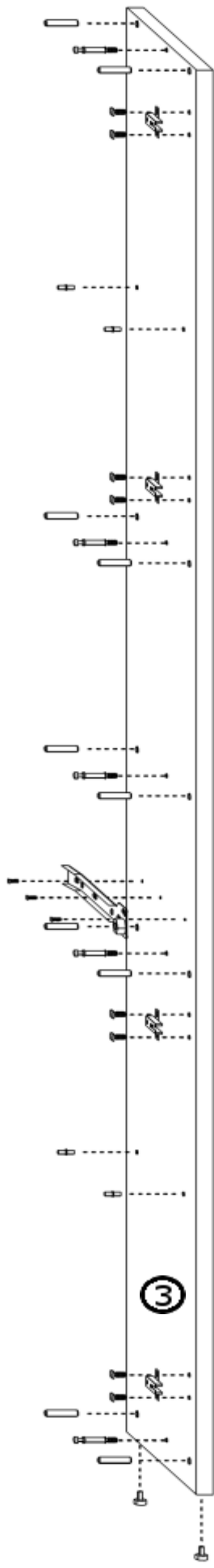

8

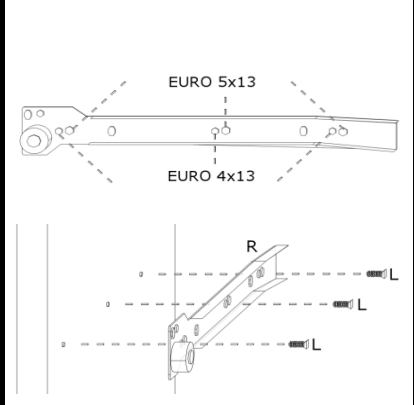
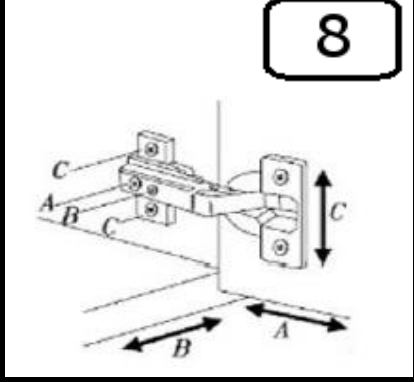

5 X

3

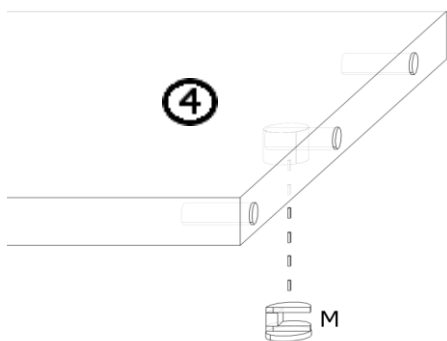

## INSTRUKCJA MONTAŻU

MONIA 2DS

5

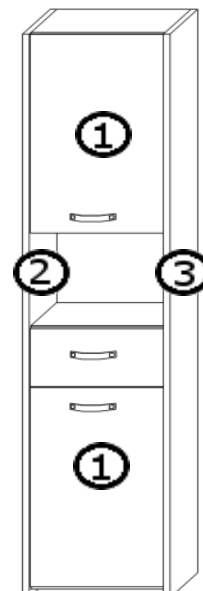
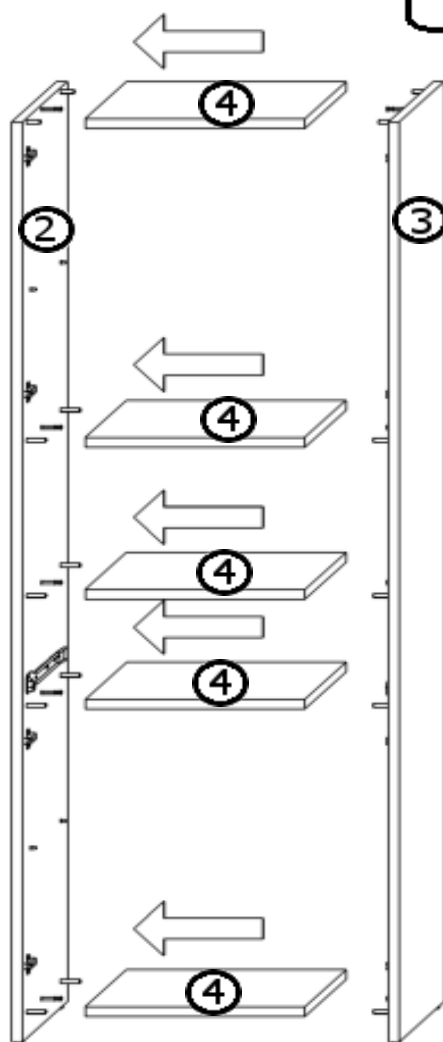

2 X

4

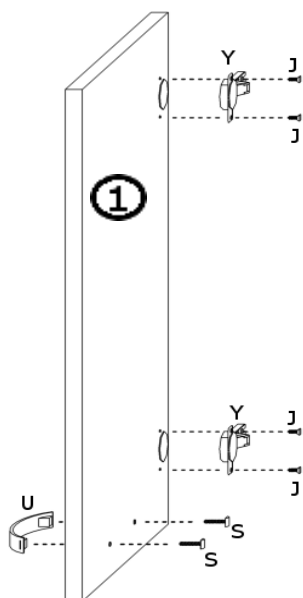

6

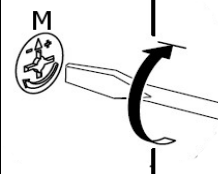





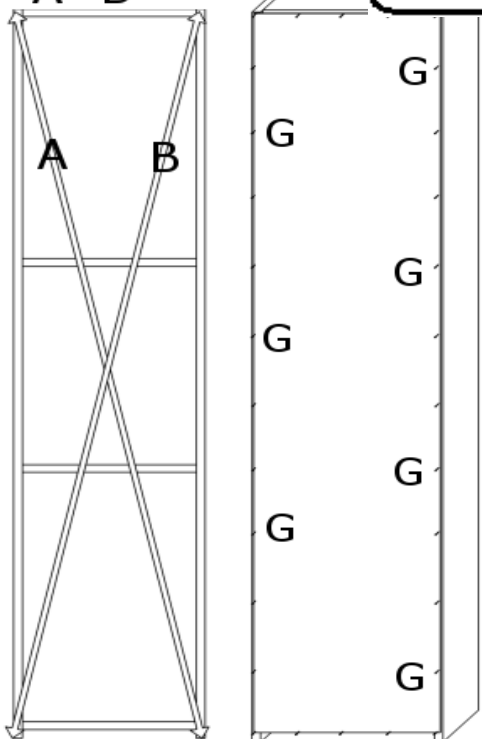





A=B

7

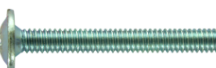

## AKCESORIA

|   |       |   |      |   |      |
|---|-------|---|------|---|------|
| R   | 1 KPL | G   | 30X  | M   | 14X  |
|  |       |  |      |  |      |
|   | 250mm |   |      |   |      |
| L   | 6X    | K   | 24X  | T   | 14X  |
|  |       |  |      |  |      |
|   | 4x13  |   |      |   |      |
|   |       | U   | 3X   | J   | 14X  |
|   |       |  |      |  |      |
|   |       |   | 96mm |   | 4x16 |
|   |       | O   | 8X   | N   | 4X   |
|   |       |  |      |  |      |
|   |       | Y+P+E   | 4X   | S   | 6X   |
|   |       |  |      |  |      |
|   |       | WPUSZCZANY  |      |   |      |

1

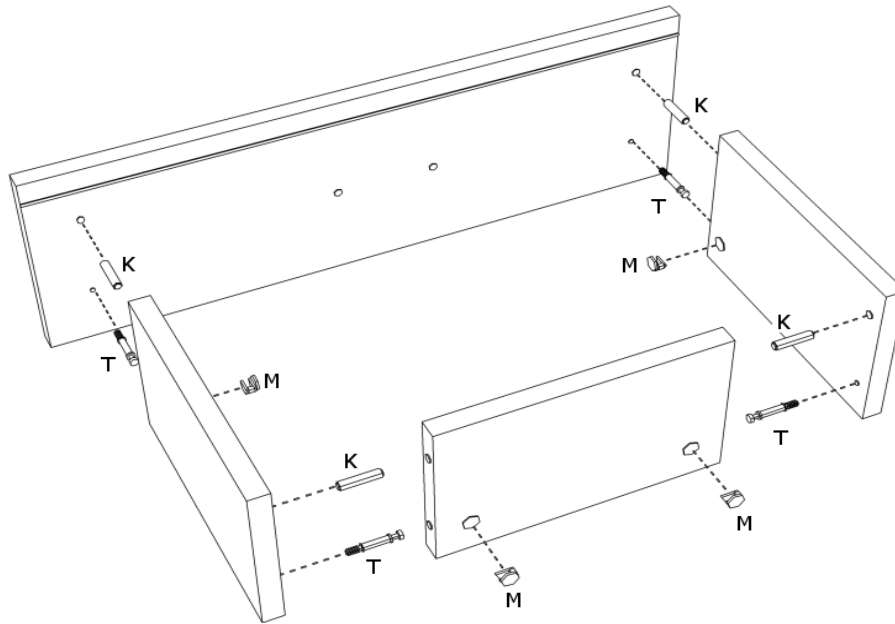

2

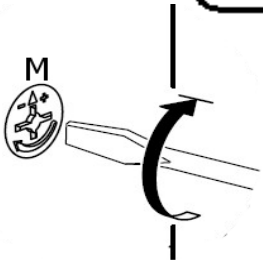

3

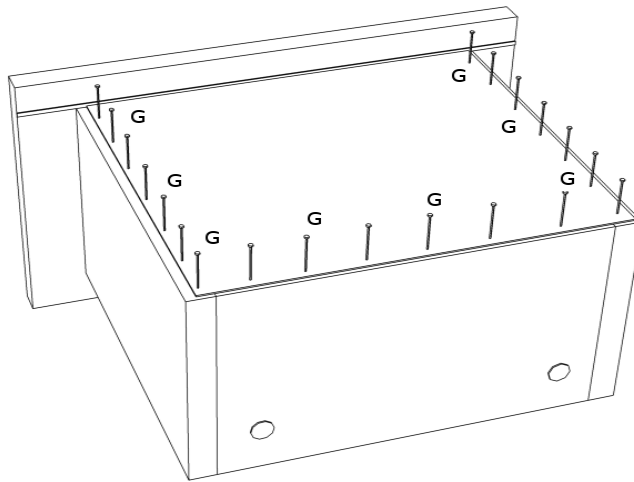

4

