

INSTRUKCJA MONTAŻU

NIKO 2KL

1

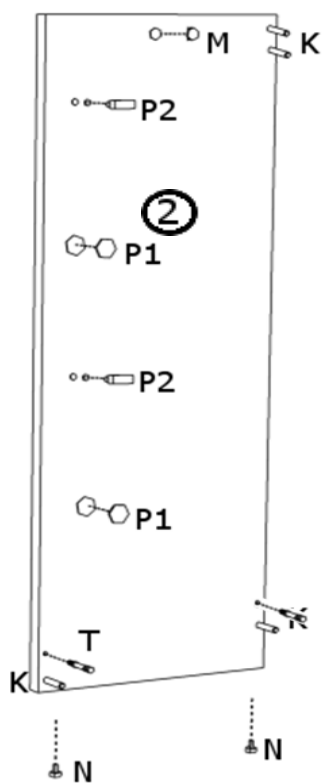

2

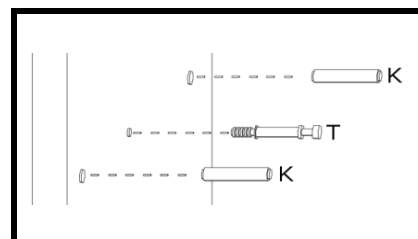
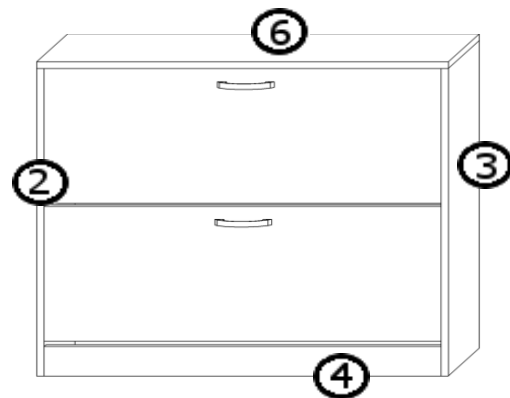

3



4



5

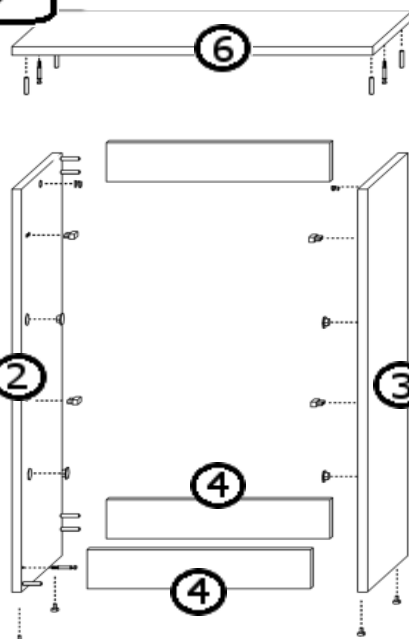

6

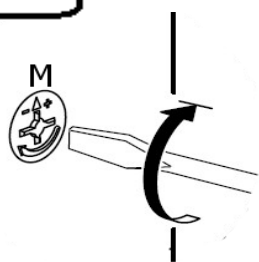

7

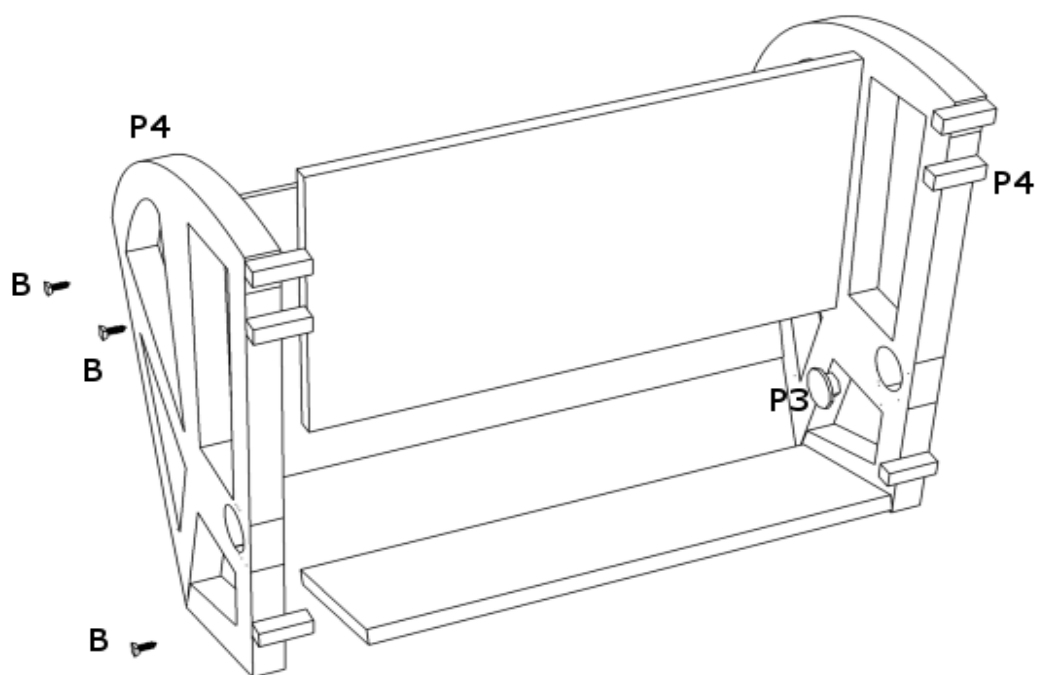
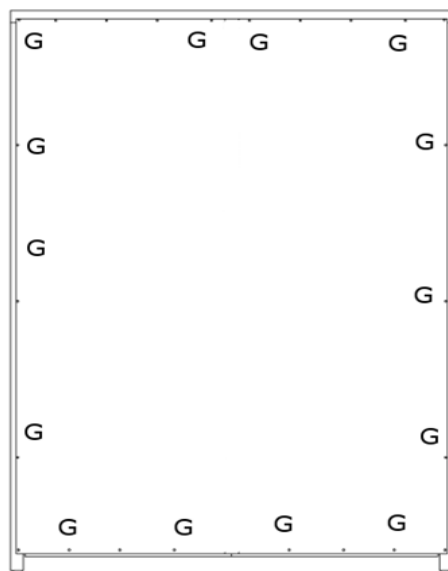
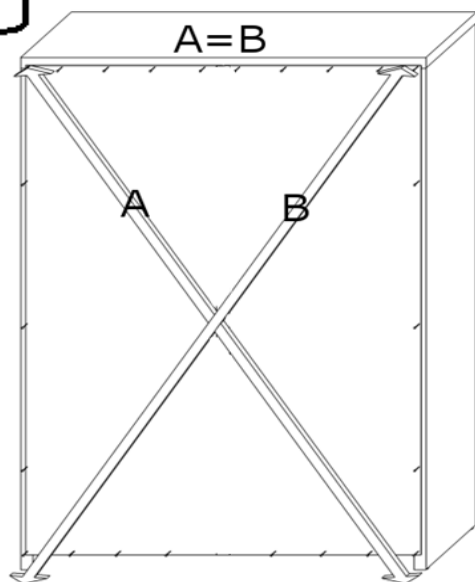

AKCESORIA

G 30X



B 12X



3X13

U 2X

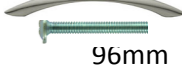

96mm

M 6X



JJ 4X

3X20



K 12X



N 4X



J 12X

4 X 16



T 6X



LŁ 1X



P4 2 KPL



P2 4X



P1 4X



P3 4X



UWAGA!!! ZMIANY NIE NA NIESIONE NA INSTRUKCJĘ:

1. blokadę P3 przykręcić na wkręt 4x20 z podkładką
2. Wkręty 4x16 służą do przykręcenia plastikowych boków do klap-drzwi.