

INSTRUKCJA MONTAŻU

NIKO 3KL

1

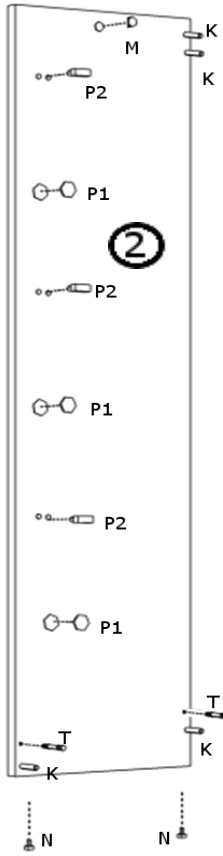

2

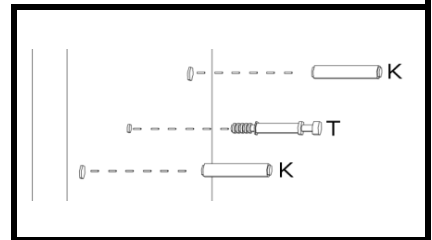
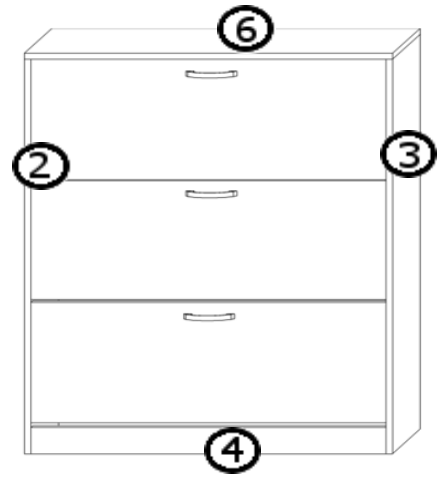
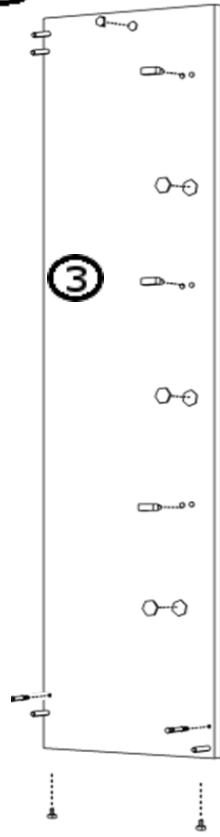

3

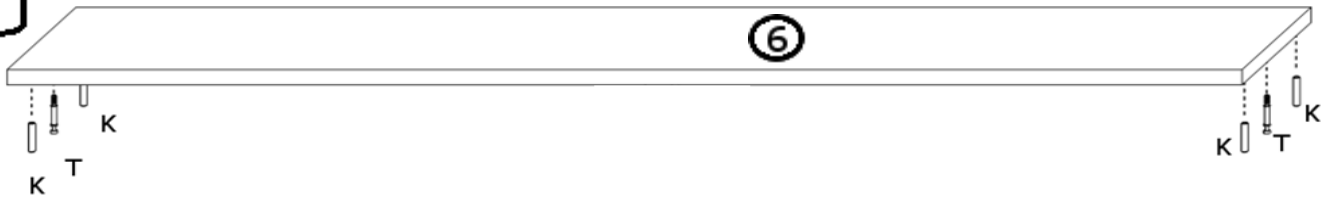

4



5

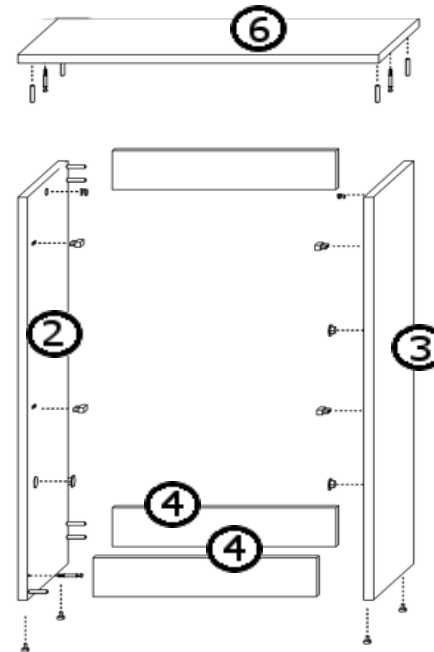

6

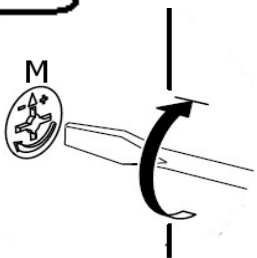

7

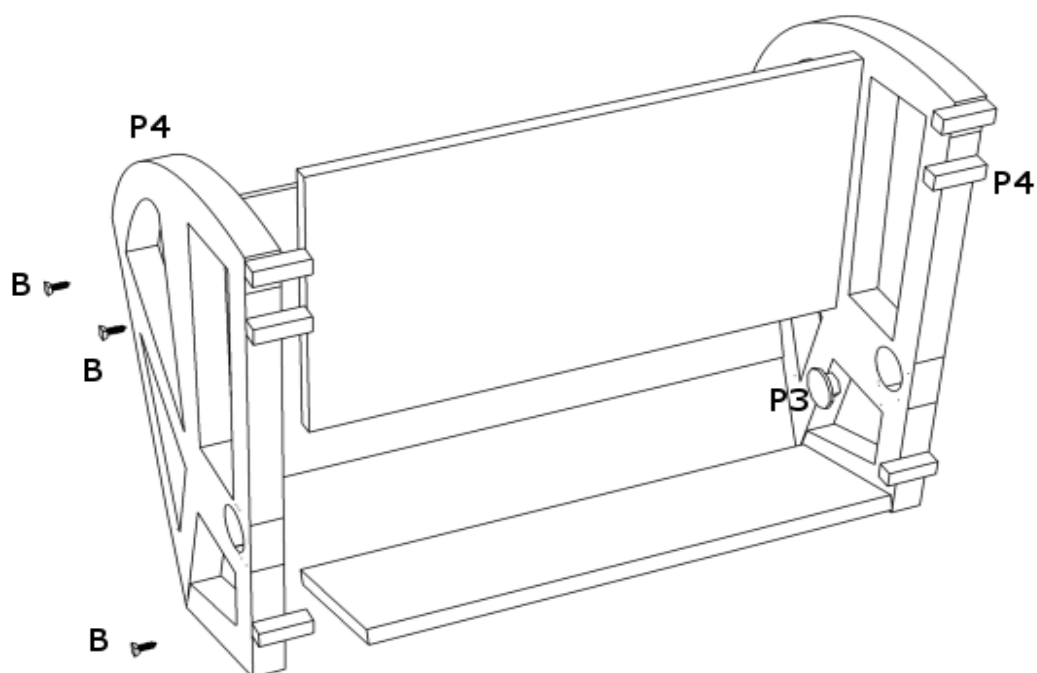
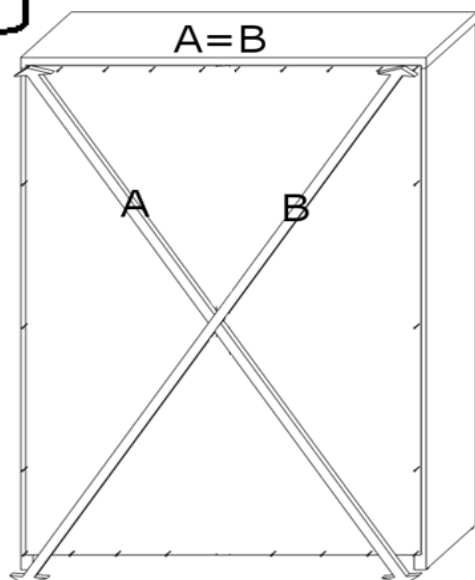

AKCESORIA

G 30X



B 18X



3X13

U 3X



96mm

M 6X



JJ 6X

3X20



K 12X



N 4X



J 18X

4 X 16



T 6X



LŁ 1X



P4 3 KPL



P2 6X



P1 6X



P3 6X



UWAGA!!! ZMIANY NIE NA NIESIONE NA INSTRUKCJĘ:

1. blokadę P3 przykręcić na wkręt 4x20 z podkładką
2. Wkręty 4x16 służą do przykręcenia plastikowych boków do klap-drzwi.