

# INSTRUKCJA MONTAŻU

TV 2S2W

1

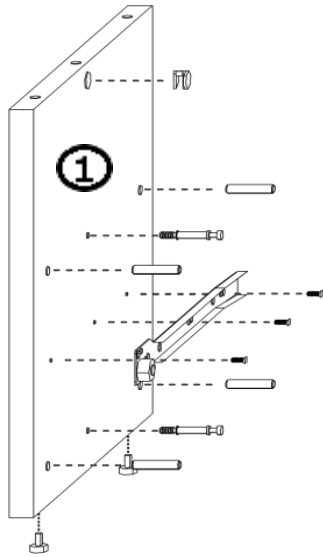

2

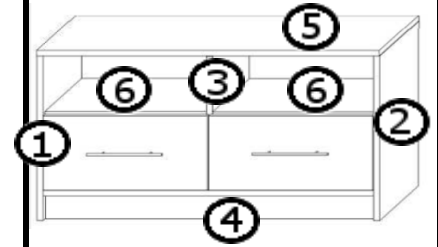
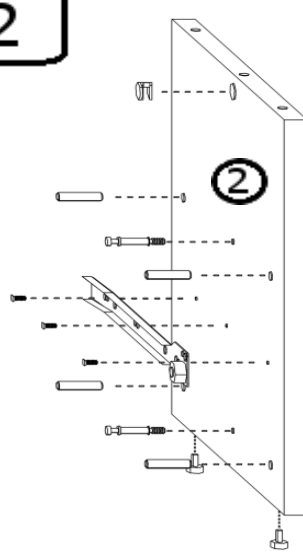

3

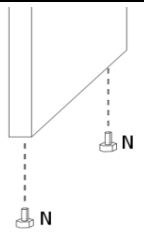
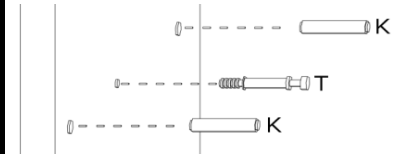
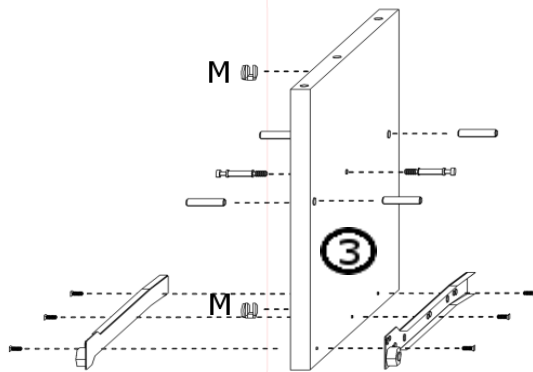

4

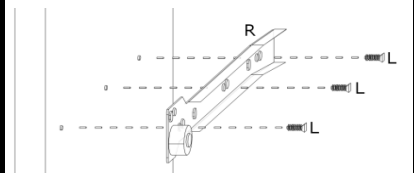
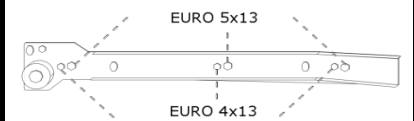
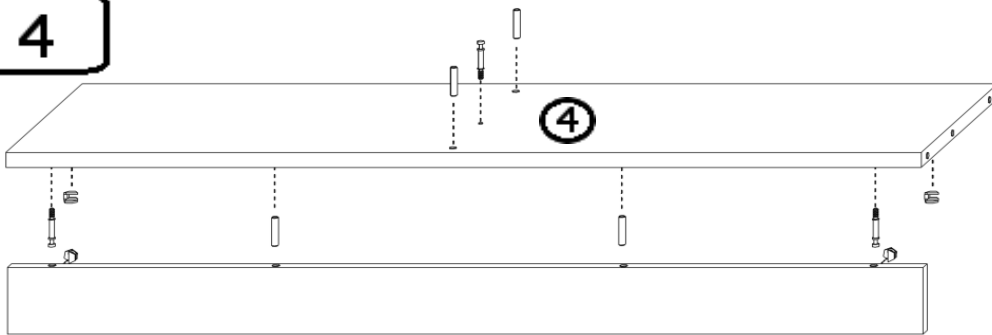

5

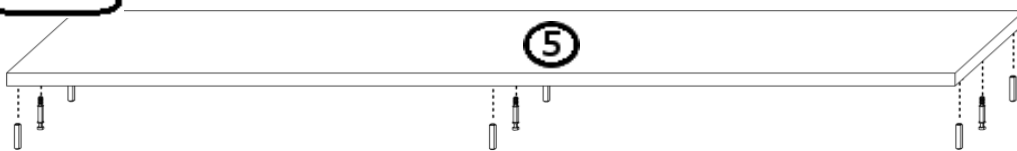

6

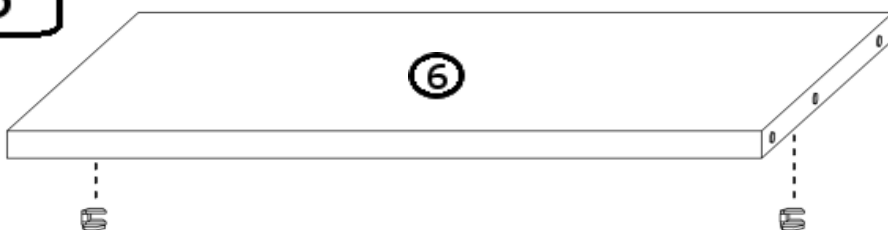

7

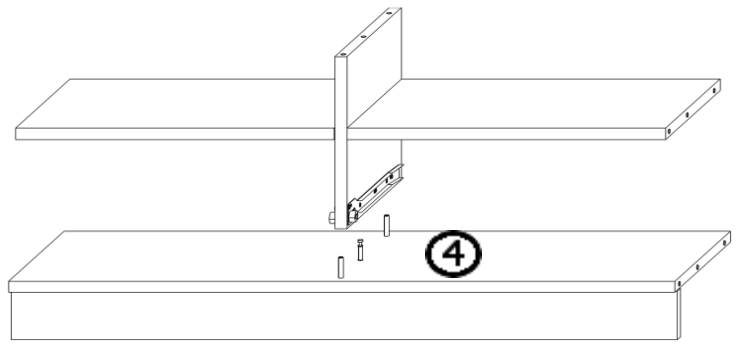
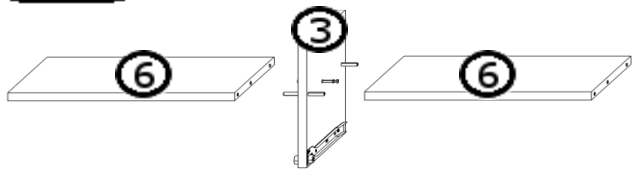

8

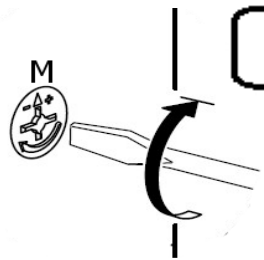
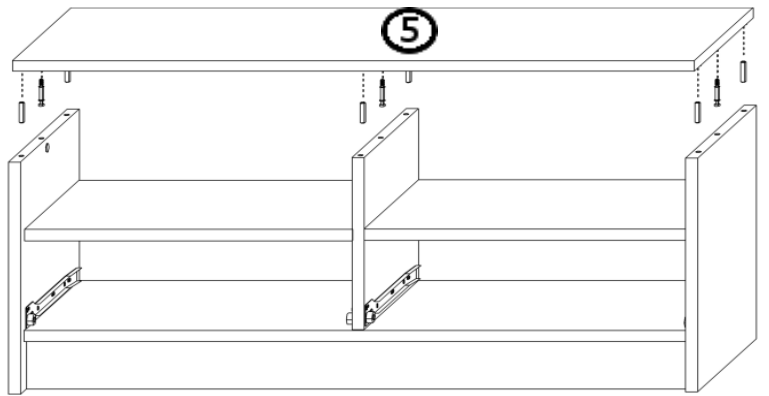
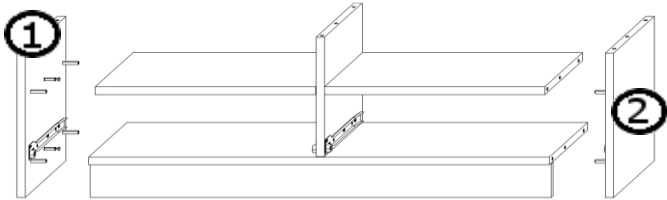





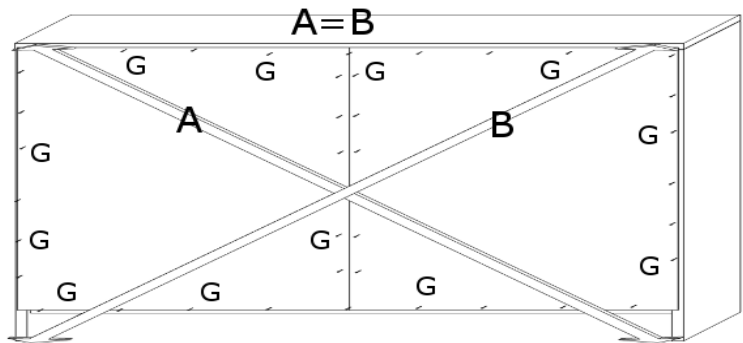





9

10

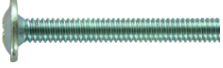

AKCESORIA

G 50X 	R 2 KPL 400mm 	U 2X 224mm 	T 20X 
L 16X 4x13 	J 16X 4x16 	S 4X 	M 20X 
K 30X 	N 4X 		

1

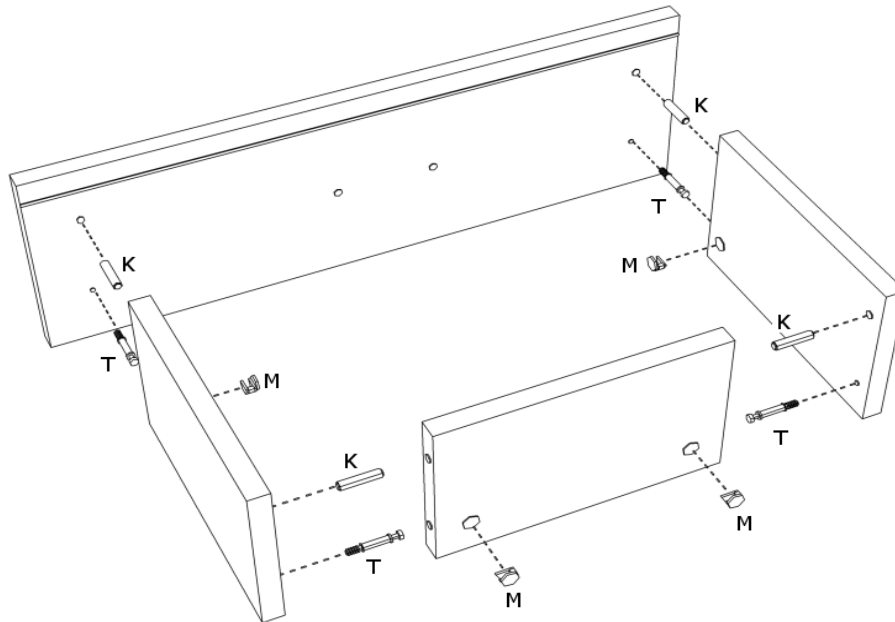

2

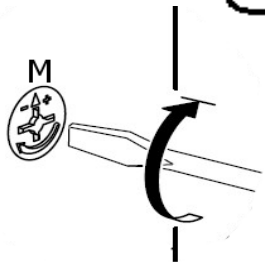

3

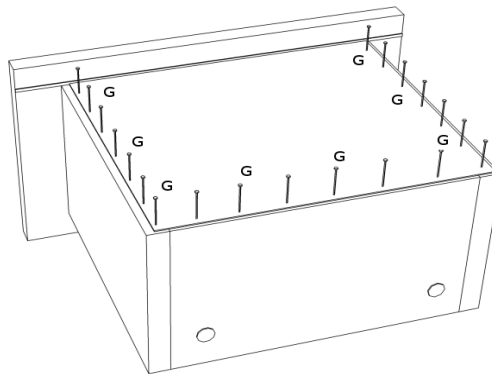

4

