

# INSTRUKCJA MONTAŻU

SZAFA VIK 2D PŁ

1

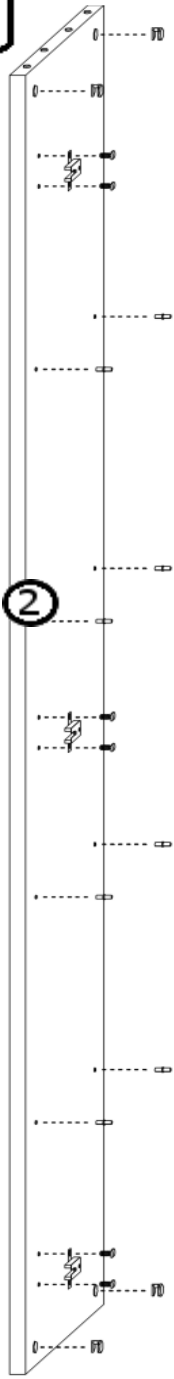

2

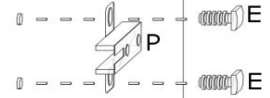
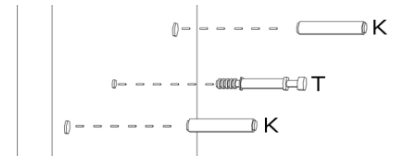
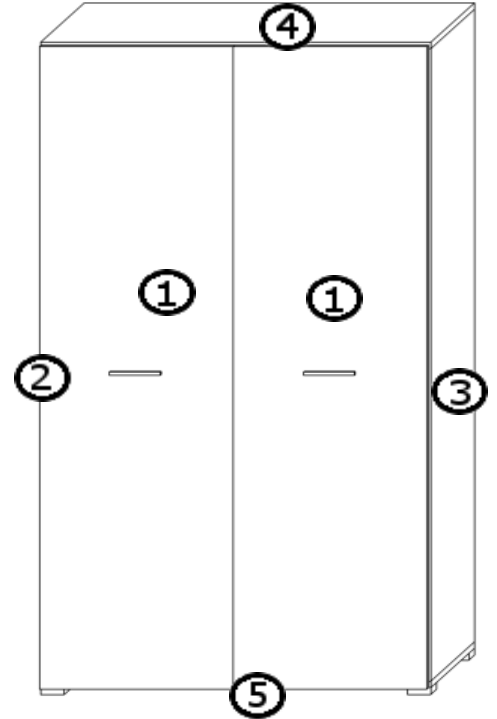
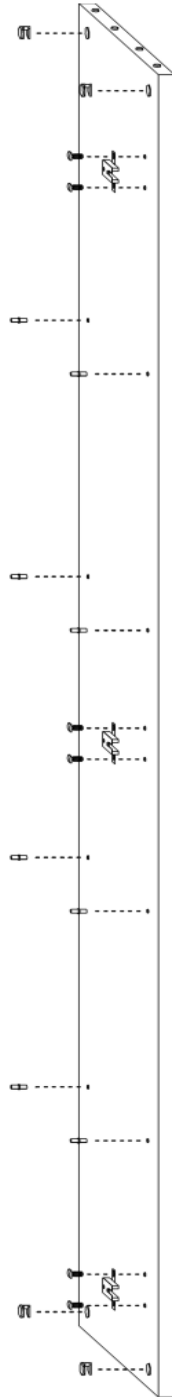



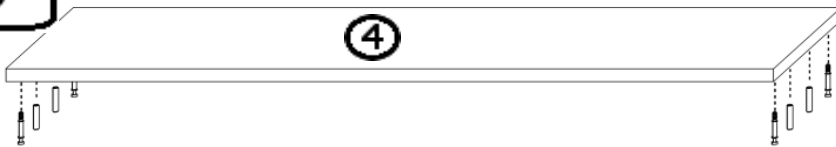

3

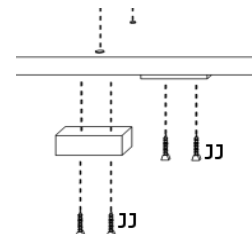
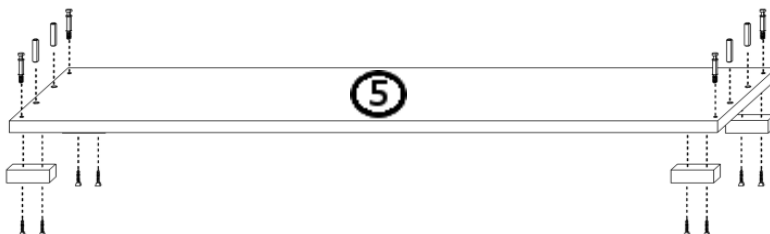

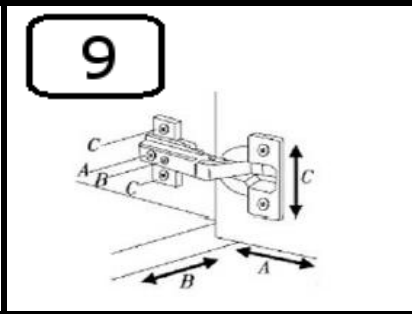
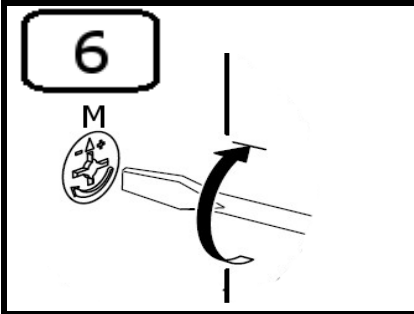
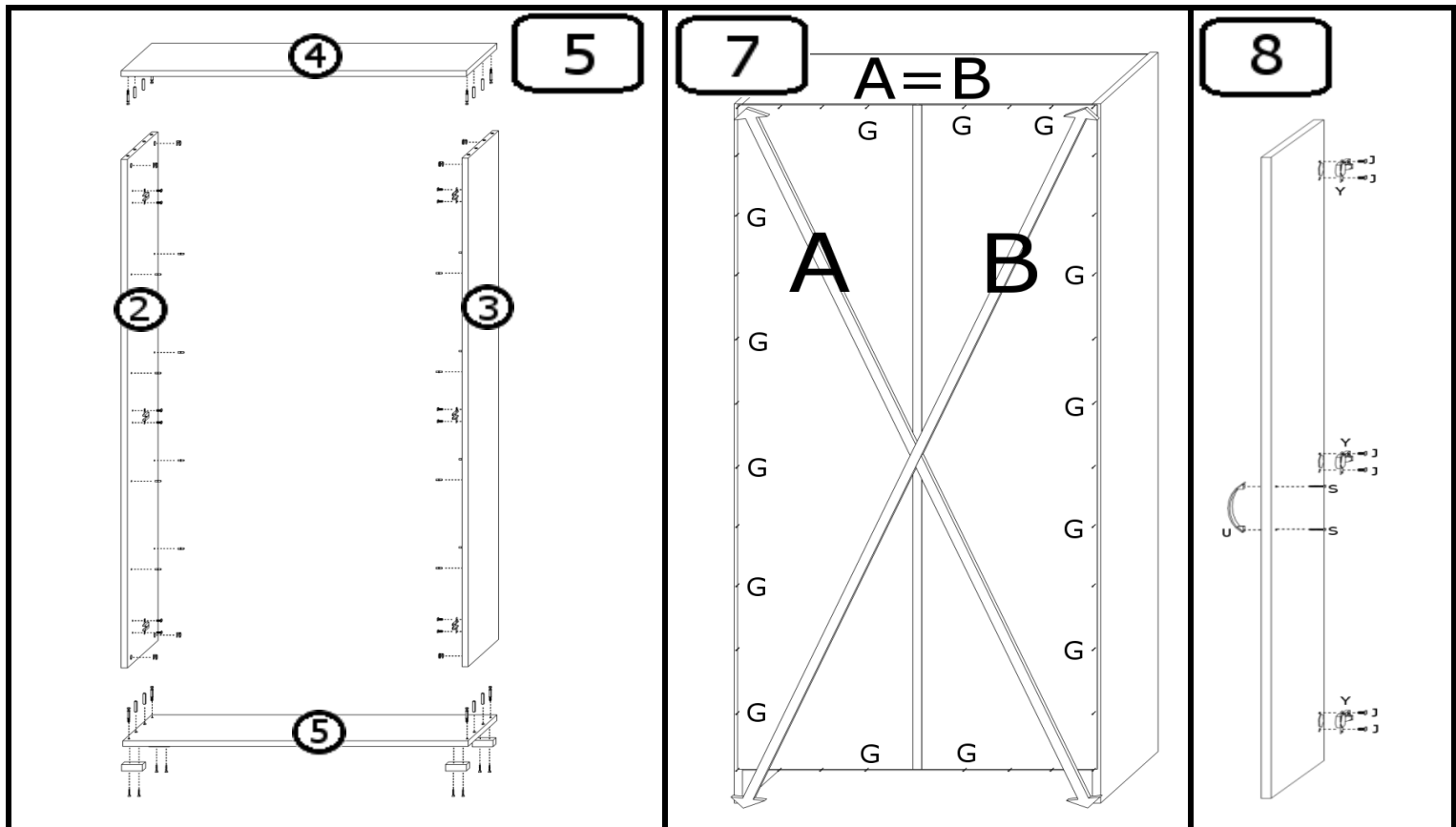
4





AKCESORIA			
G 30X 	O 16X 	U 2X 	T 8X 
K 8X 	Y 6X 	S 4X 	M 8X 
LŁ 1X 	JJ 8X 	J 12X 	NP. 4X 